







Materials	Steel frame canopy and hardware Handblown, sandblasted glass shades and borosilicate beads
Dimensions	11 3/4 in (29.8 cm) W x 11 3/4 in (29.8 cm) D x 42 in (106.6 cm) H
Weight	30 lbs (13.6 kg)
Packing	24 in (60.9 cm) W x 12 in (30.4 cm) D x 12 in (30.4 cm) H 25 lbs (11.3 kg)
Canopy	8 in (11.5 cm) W x 8 in (11.5 cm) D x 1 3/8 in (3.4 cm) H
Drop height	19 7/8 in (50.4 cm) H Custom upon request, adjustable on site
Lamping	1 x G9 socket G9 LED bulbs (provided) 2.5W 2700K 250 lm

Finishes	Frame
	Chrome
	Polished Brass
	Polished Black Nickel
	Globe (glossy or sandblasted)
	Smoke
	Clear
	Frosted
	Grey



Handmade in Los Angeles

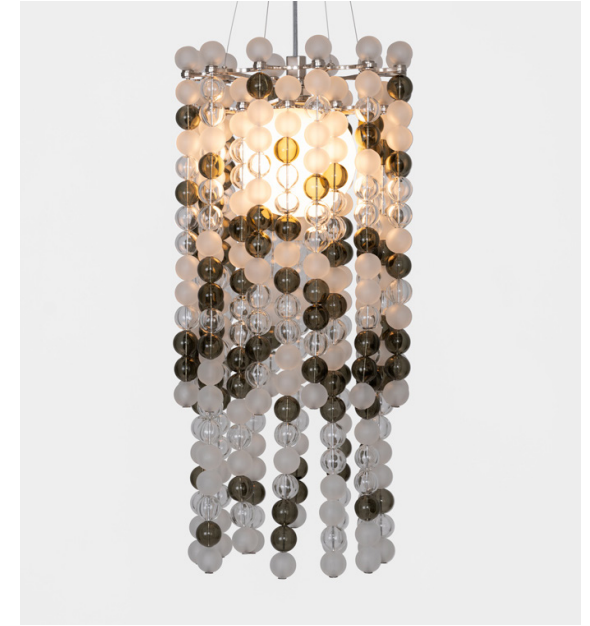
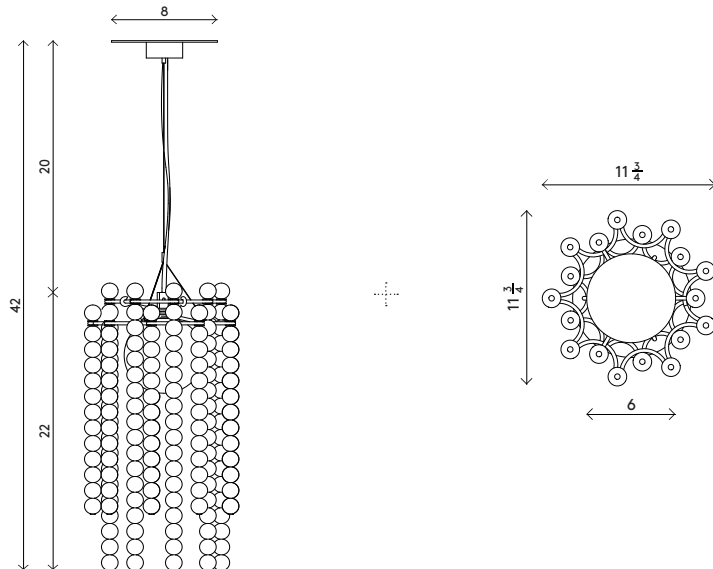

Bulb life	25,000 hrs
Dimming	10-100%. Wattage +/- 10% Lumen Values +/- 5Lms CRI +/- 5% Fully tested with LUTRON® DVCL, DVCL
Voltage	120 V / 240
Certification	UL, CE listed Damp rated

Handmade in Los Angeles  
Hardwired